

LCM Specification

Preliminary specification

Final Specification

| | | | |
|-------------------------------------------|---------------------------------------------------------|------------------------------------------|-----|
| Project No. 项目编号 | TFT-H035A1QVIST6C54 | | |
| Customer 客户名称 | | | |
| Module No. 客户型号 | | | |
| Product type 产品内容 | TFT LCD Module 320 x 3RGB x 240 Dots 3.5" TFT LCD | | |
| Signature by customer: 客户确认签章: | | | |
| <input type="checkbox"/> Trial production | | <input type="checkbox"/> Mass production | |
| 编 制 | 电子审核 | 结构审核 | 批 准 |
| Y. L | | | |

深圳市鑫洪泰电子科技有限公司

Shenzhen Hot Display Technology Co., Ltd

1 Document revision history :

| DOCUMENT REVISION | DATE | DESCRIPTION | PREPARED BY | APPROVED BY |
|-------------------|----------|----------------|-------------|-------------|
| 0 | 2019-5-6 | First Release. | Y.L | |

1. General Feature:

| Item | Standard Value | Unit |
|-------------------------|------------------------------|------|
| Display Size | 3.5" | -- |
| Number of Pixels | 320(H)x3(RGB)*240(V) | -- |
| Active Area | 70.08(H) *52.56(V) | mm |
| LCM Outline Dimension | 76.84(H) ×63.84× 4.65(V) | mm |
| Viewing Direction | Full O'Clock | - |
| LCM Interface | 8/24-bit RGB with 3-wire SPI | - |
| LCM Driver IC | ST7272A | - |
| LCM Driver Voltage | VCI=2.8V | V |
| Backlight | White LED | - |
| Touch Panel | With Touch Panel | - |
| CTP Driver IC | FT5216 | - |
| CTP Driver Voltage | VDD=3.3 | V |
| CTP I/O Digital Voltage | VDD=3.3 | V |
| Operation Temperature | -30~85 | °C |
| Storage Temperature | -40~85 | °C |

2.Outline Dimensions

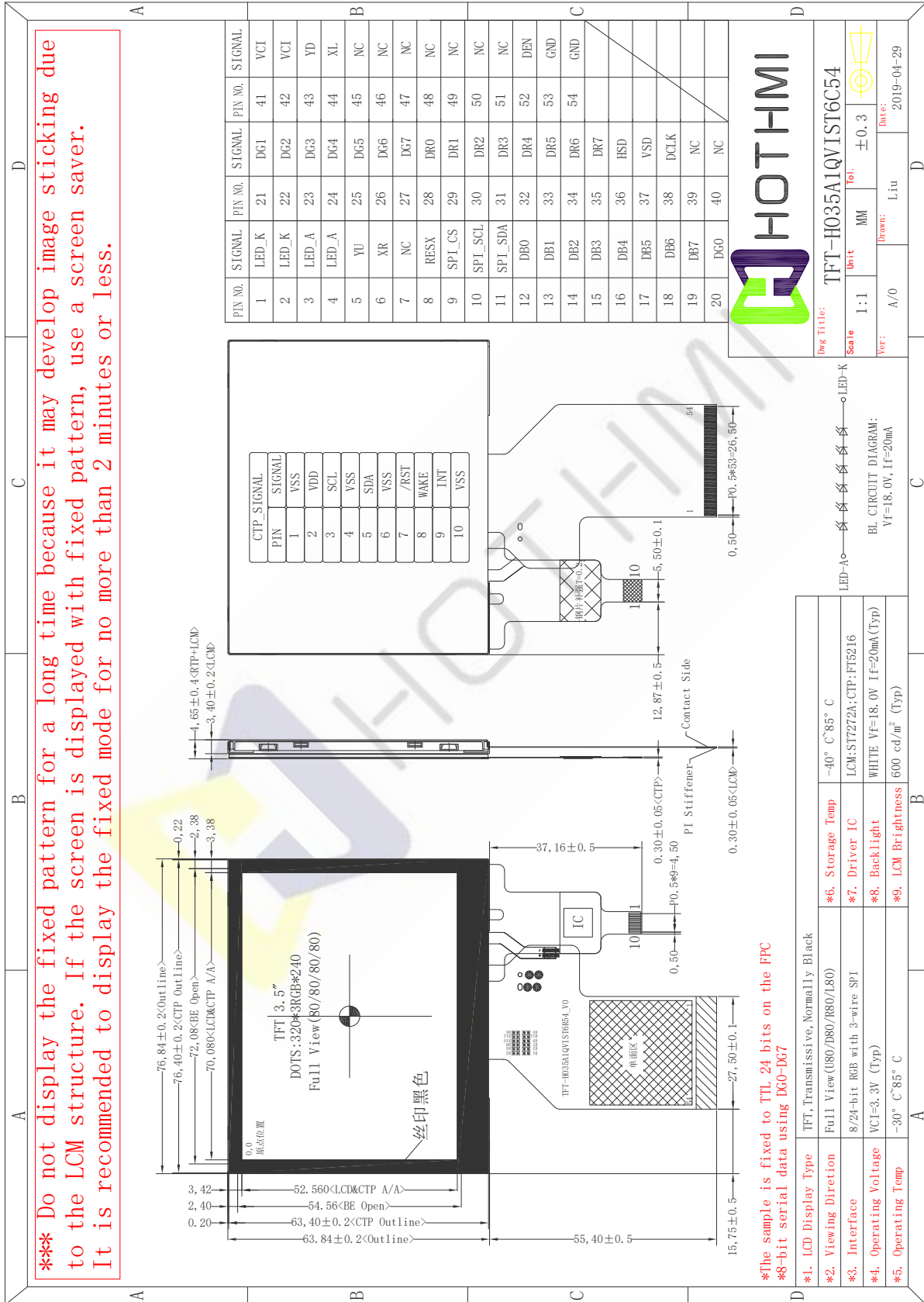

3. Pin Description

3.1 LCM Pin Description

| Pin NO. | Symbol | Description |
|---------|---------|-----------------------------------------------------------------------------------------------------------------------------------------------|
| 1, 2 | LED_K | LED Cathode |
| 3, 4 | LED_A | LED Anode |
| 5 | RTP_YU | Resistive TP function pin. If not used, let this pin open. |
| 6 | RTP_XR | Resistive TP function pin. If not used, let this pin open. |
| 7 | NC | No Connect |
| 8 | RESX | LCM Reset Pin. |
| 9 | SPI_CS | <ul style="list-style-type: none"> ◆ Chip select input pin (“Low” enable). ◆ If not used, please fix this pin at VCI. |
| 10 | SPI_SCL | <ul style="list-style-type: none"> ◆ In SPI mode, this pin is used as SCL. ◆ If not used, please let this pin open. |
| 11 | SPI_SDA | <ul style="list-style-type: none"> ◆ SPI interface input/output pin. ◆ If not used, please let this pin open. |
| 12-19 | DB0-DB7 | Blue data bus. If not used, please fix this pin at GND. |
| 20-27 | DG0-DG7 | Green data bus. DG[7:0] are used in 8-bit RGB interface. |
| 28-35 | DRO-DR7 | Red data bus. If not used, please fix this pin at GND. |
| 36 | HSD | Horizontal sync signal, default is negative polarity. |
| 37 | VSD | Vertical synchronizing input signal for RGB interface. |
| 38 | PCLK | Pixel clock input pin. |
| 39, 40 | NC | No Connect |
| 41, 42 | VCI | Analog Power |
| 43 | RTP_YD | Resistive TP function pin. If not used, let this pin open. |
| 44 | RTP_XL | Resistive TP function pin. If not used, let this pin open. |
| 45-51 | NC | No Connect |
| 52 | DEN | Data input enable. Display access is enabled when DE is “H”. |
| 53, 54 | GND | Ground |
| - END - | | |

3.2 CTP Pin Description

| Pin NO. | Symbol | Description |
|---------|--------|-------------------------------|
| 1 | VSS | Ground |
| 2 | VDD | Power Supply Voltage |
| 3 | SCL | Clock input |
| 4 | VSS | Ground |
| 5 | SDA | Data input and output |
| 6 | VSS | Ground |
| 7 | /RST | External Reset, active low |
| 8 | WAKE | Wakeup request from the host |
| 9 | INT | Interrupt request to the host |
| 10 | VSS | Ground |

3.3 Wiring Diagram

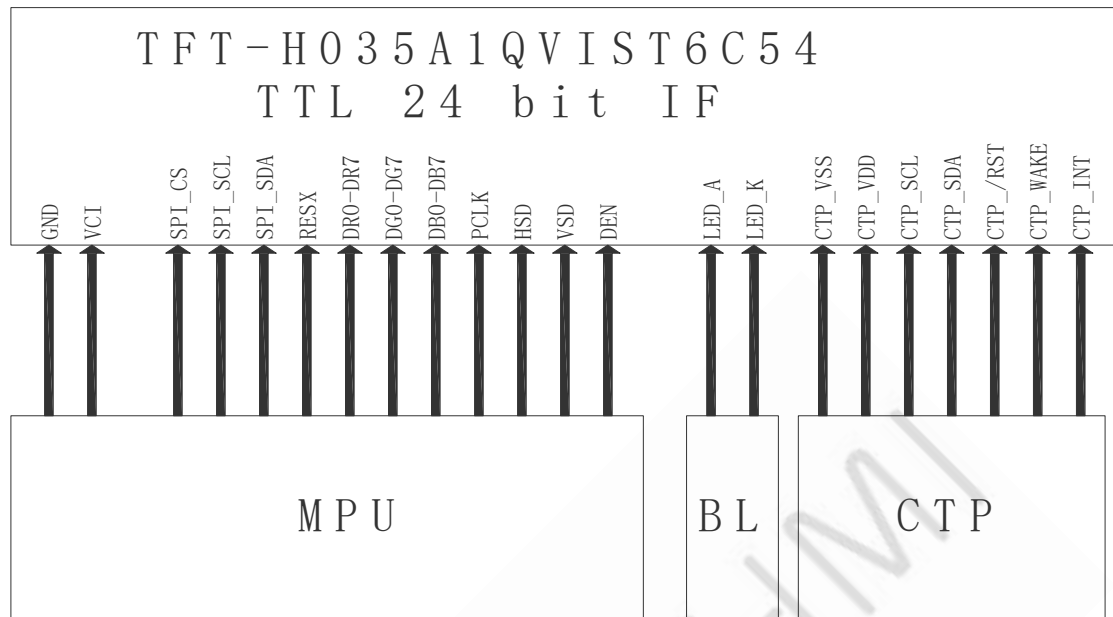

*The sample is fixed to TTL 24 bits on the FPC

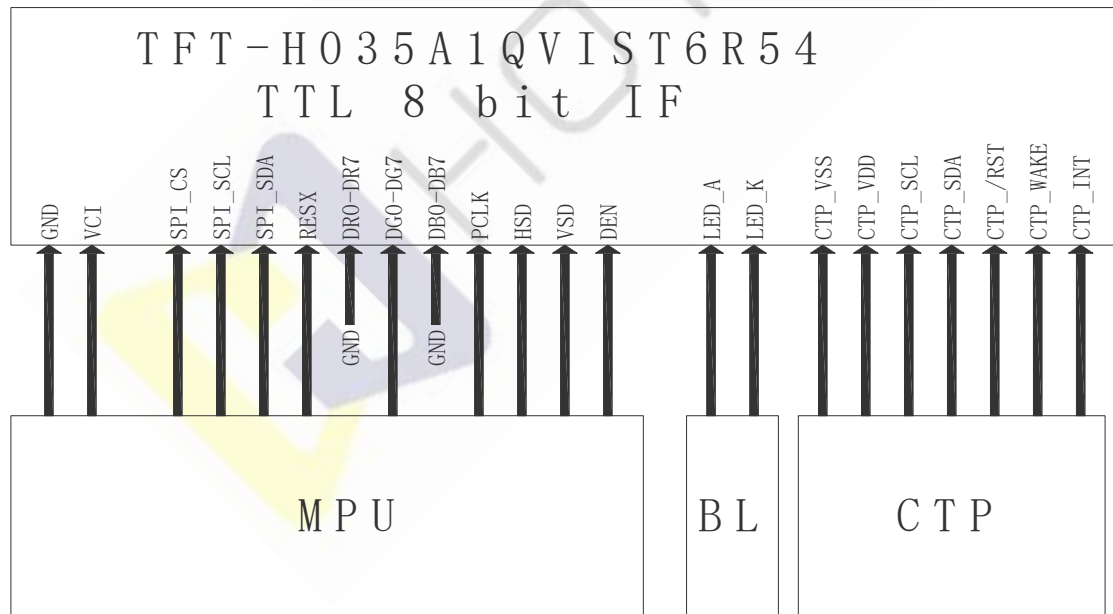

* Also need to change the resistance position on the FPC from R6 to R5

| RGB Mode Selection Table | PCLK | HSD | VSD | DEN |
|--------------------------|-------|-------|-------|-------|
| SYNC - DE Mode | Input | Input | Input | Input |
| SYNC Mode | Input | Input | Input | GND |
| DE Mode | Input | GND | GND | Input |

4. Electrical Characteristics

4-1 TFT LCD Module Operating Conditions

| Item | Symbol | Condition | Min | Type | Max | Unit |
|--------------------------|--------|-----------|-----|-------|-----|------|
| Interface logic circuits | IOVCC | - | - | - | - | V |
| Analog Power supply | VCI | - | 3.0 | 3.3 | 3.6 | V |
| TFT Gate on voltage | VGH | - | - | 14.6 | - | V |
| TFT Gate off voltage | VGL | - | - | -10.0 | - | V |

4-2 LED back light specification (pera chip)

| Item | Symbol | Condition | Min | Type | Max | Unit |
|---------------------|--------|-----------|------|------|------|-------------------|
| Forward voltage | Vt | If=20mA | 16.8 | 18.0 | 20.4 | V |
| Forward current | Ipn | /1-chip | - | 20 | - | mA |
| Luminance(With LCD) | Lv | If=20mA | - | 600 | - | cd/m ² |
| Luminous color | White | | | | | |

4-3 CTP Operating Conditions

| Item | Symbol | Condition | Min | Type | Max | Unit |
|-----------------------|--------|-----------|-----|------|-----|------|
| Power Supply Voltages | VDD | - | 2.8 | - | 3.3 | V |
| I/O Digital Voltage | IOVDD | - | 2.8 | - | 3.3 | V |
| Operating Temperature | Topr | - | - | - | - | °C |
| Storage Temperature | Tstg | - | - | - | - | °C |

4. OPTICAL SPECIFICATION

4.1 Overview

The test of Optical specifications shall be measured in a dark room (ambient luminance 1lux and temperature = 25 ± 2°C) with the equipment of Luminance meter system (Goniometer system and TOPCON BM-5) and test unit shall be located at an approximate distance 50cm from the LCD surface at a viewing angle of θ and Φ equal to 0°. The center of the measuring spot on the Display surface shall stay fixed. The backlight should be operating for 30 minutes prior to measurement.

4.2 Optical Specifications

| Parameter | | Symbol | Condition | Min. | Typ. | Max. | Unit | Remark |
|----------------------------------|------------|------------|--------------------------------|------|-------|------|------|-----------------------------|
| Viewing Angle Range | Horizontal | Θ L | CR>10 | - | 80 | - | Deg. | Note 1 |
| | | Θ R | | - | 80 | - | Deg. | |
| | Vertical | Θ U | | - | 80 | - | Deg. | |
| | | Θ D | | - | 80 | - | Deg. | |
| Contrast ratio | | CR | $\Theta = 0^\circ$ | - | 800 | - | | Note2 |
| Color Gamut | | CG | | - | - | - | % | |
| White Chromaticity | | Wx | | - | 0.317 | - | | |
| | | Wy | | - | 0.339 | - | | |
| Reproduction of color | Red | Rx | $\Theta = 0^\circ$ | - | 0.646 | - | | Note4 (Based on C Light) |
| | | Ry | | - | 0.332 | - | | |
| | Green | Gx | | - | 0.323 | - | | |
| | | Gy | | - | 0.567 | - | | |
| | Blue | Bx | | - | 0.134 | - | | |
| | | By | | - | 0.121 | - | | |
| Response Time (Rising + Falling) | | Tr+Tf | $\Theta = 0^\circ$ Ta= 25°C | - | 30 | - | ms | Note5 |
| Transmittance | | Tr | | - | - | - | % | Note3 |

Note:

1. Viewing angle is the angle at which the contrast ratio is greater than 10. The viewing angles are determined for the horizontal or 3, 9 o' clock direction and the vertical or 6, 12 o' clock direction with respect to the optical axis which is normal to the LCD surface (see FIGURE 1).

2. Contrast measurements shall be made at viewing angle of $\Theta = 0$ and at the center of the LCD surface. Luminance shall be measured with all pixels in the view field set first to white, then to the dark (black)

state . (see FIGUR 1) Luminance Contrast Ratio (CR) is defined mathematically.

$$CR = \frac{\text{Luminance when displaying a white raster}}{\text{Luminance when displaying a black raster}}$$

3. Transmittance is the Value without APF and without CG.

4. The color chromaticity coordinates specified in the above table shall be calculated from the spectral data measured with all pixels first in red, green, blue and white. Measurements shall be made at the center of the panel.

5. The electro-optical response time measurements shall be made as FIGURE 2 by switching the “data” input signal ON and OFF. The times needed for the luminance to change from 10% to 90% is T_r , and 90% to 10% is T_f .

Figure1 Measurement Set Up

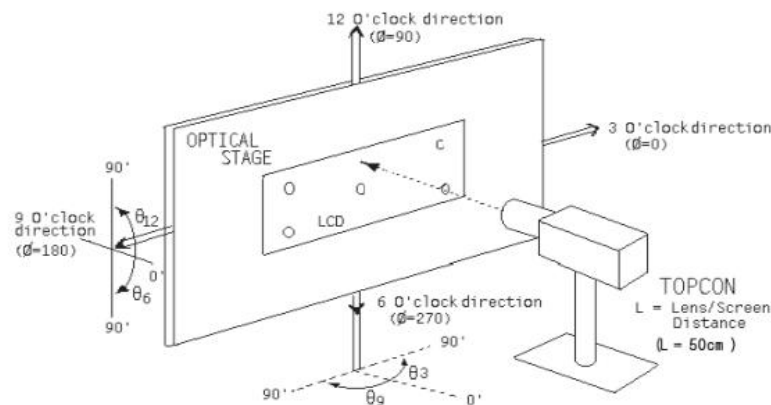
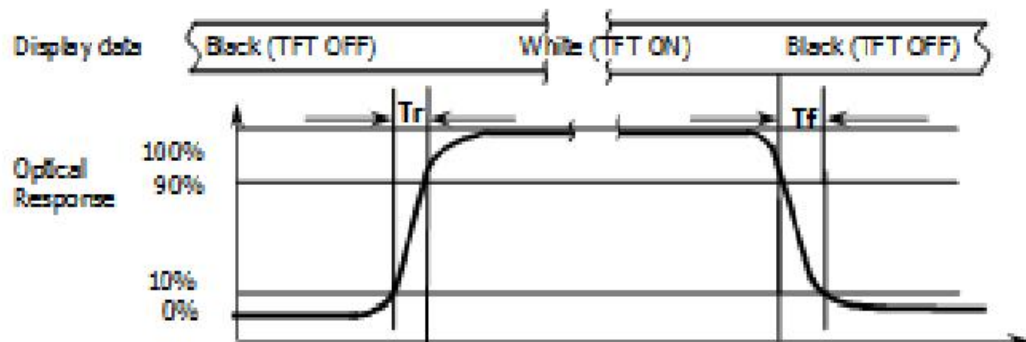
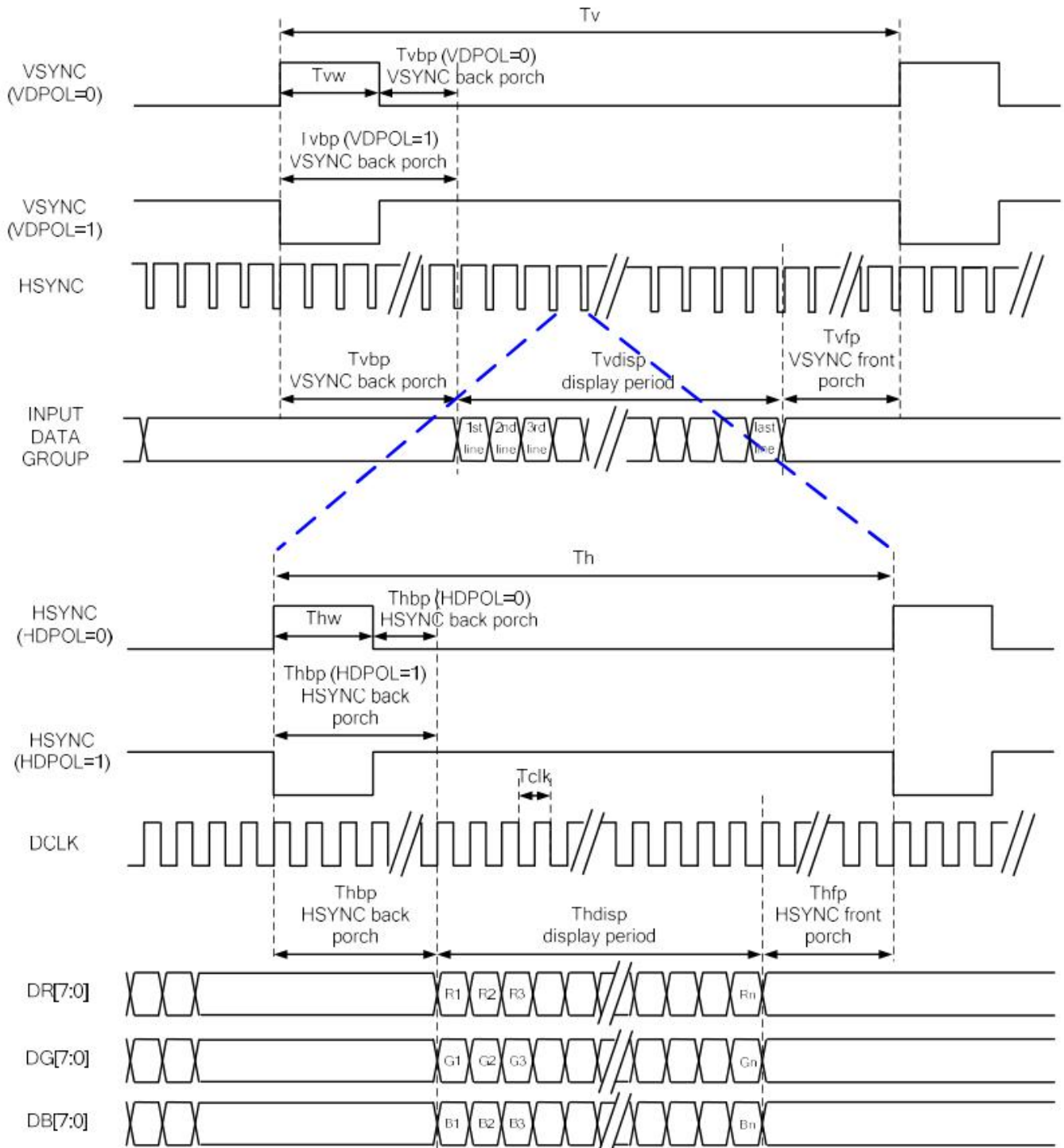

Figure2 Response Time Testing



6. Timing Characteristics of Input Signals

6-1 Parallel RGB SYNC Mode



6-4 Serial RGB SYNC-DE Mode

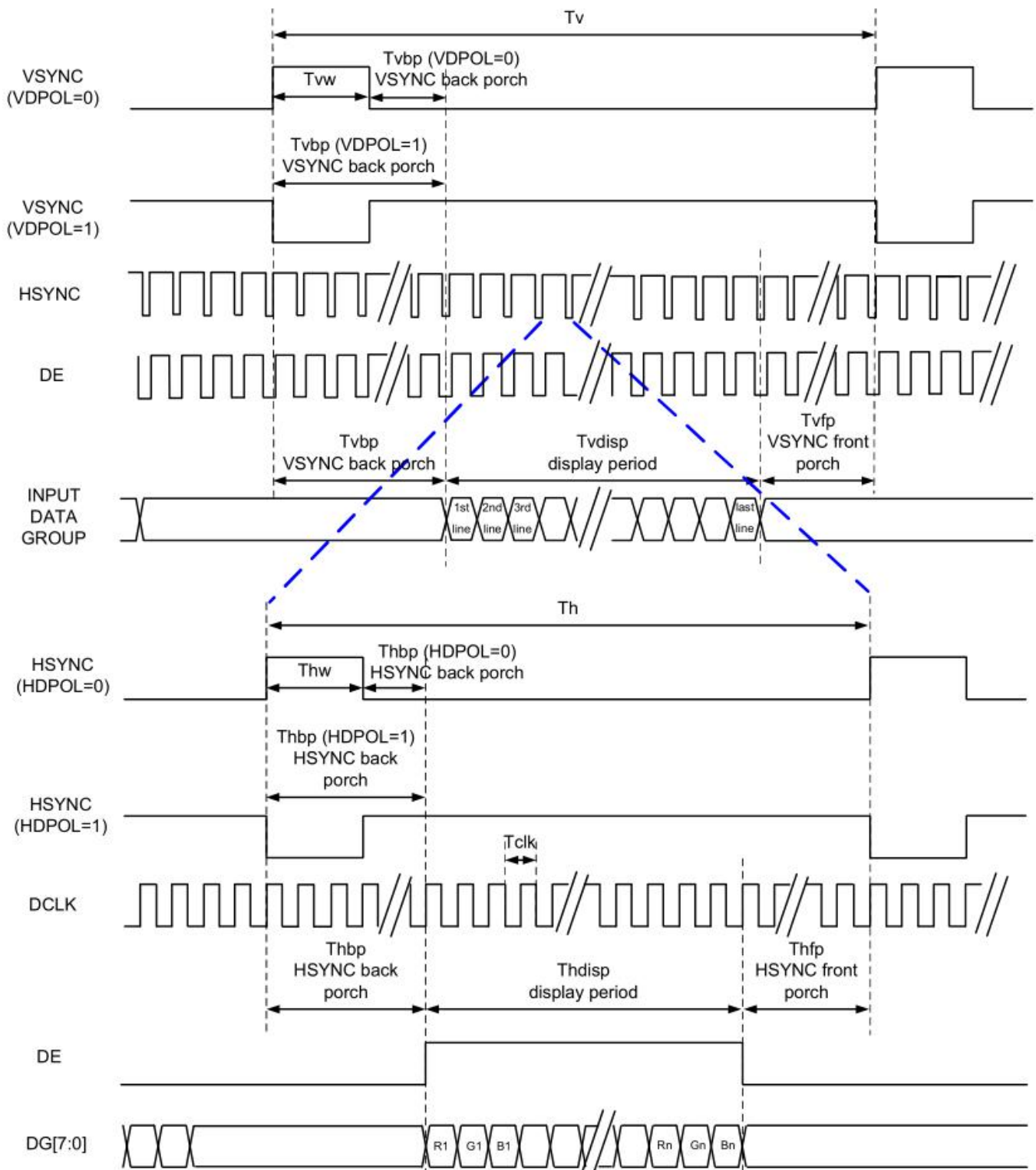

6-5 Parallel RGB DE Mode

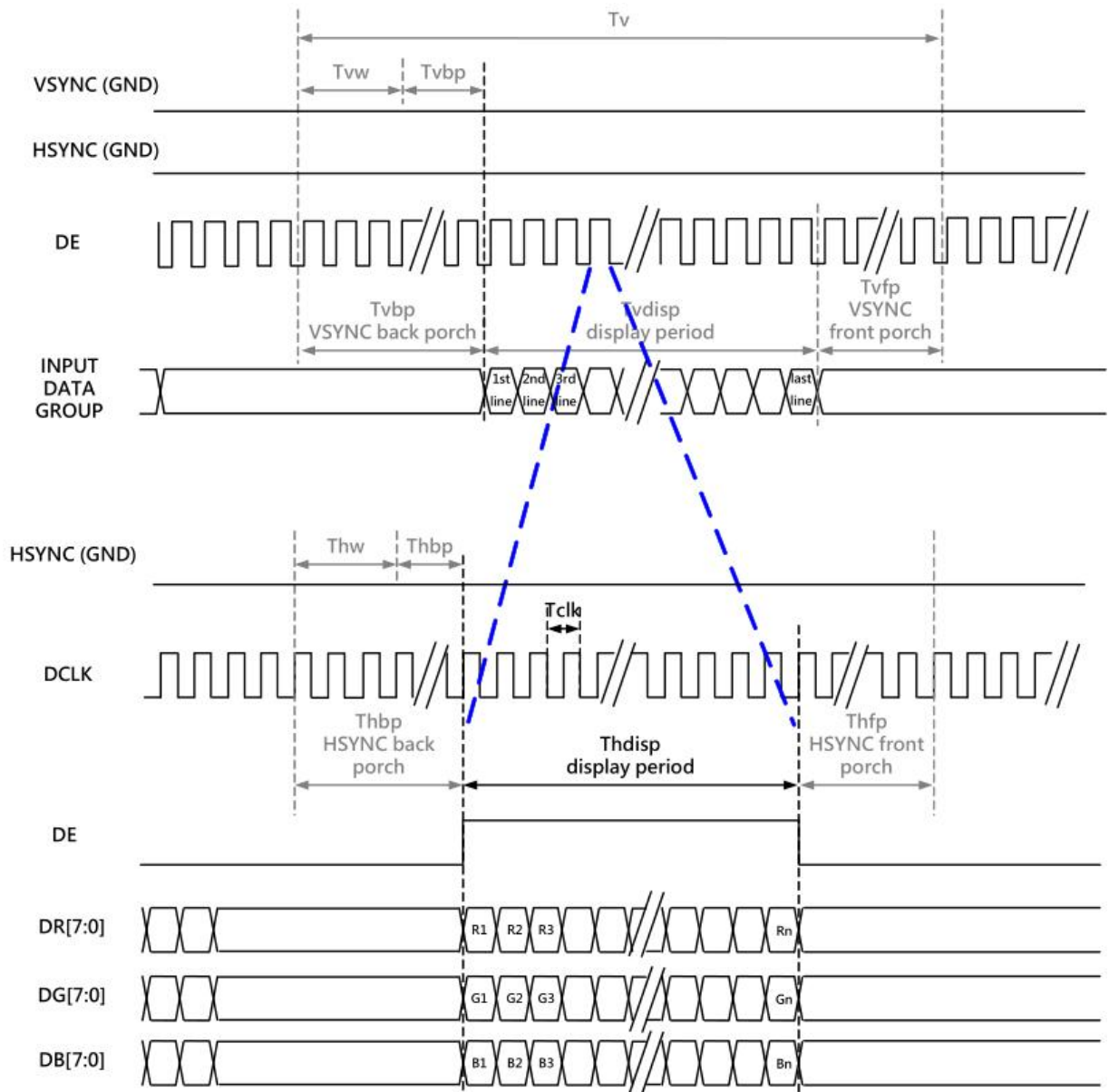

6-6 Serial RGB DE Mode

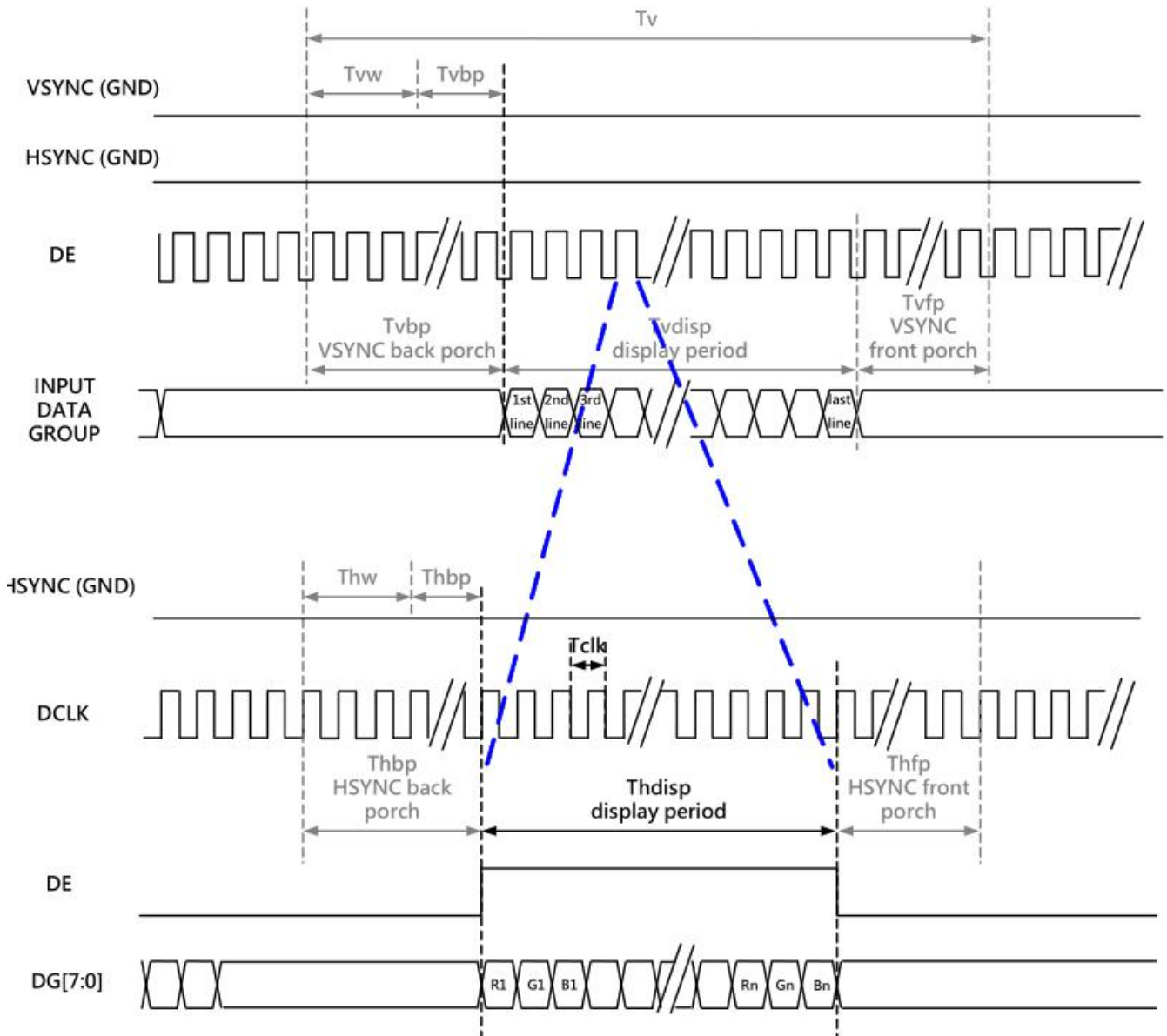

6-7 Parallel RGB Input Timing Table

Parallel 24-bit RGB Input Timing (PVDD=VDD=VDDI= 3.3V, AGND= 0V, TA=25°C)

| Parallel 24-bit RGB Input Timing Table | | | | | | | |
|----------------------------------------|----------------|--------|------|------|------|-------|----------------------------------------------------------------------------------|
| Item | Symbol | Min. | Typ. | Max. | Unit | Note | |
| DCLK Frequency | Fclk | 5 | 6 | 8 | MHz | | |
| DCLK Period | Tclk | 125 | 167 | 200 | ns | | |
| HSYNC | Period Time | Th | 325 | 371 | 438 | DCLK | |
| | Display Period | Thdisp | | 320 | | DCLK | |
| | Back Porch | Thbp | 3 | 43 | 43 | DCLK | SYNC mode back porch control by H_BLANKING[7:0] setting Thbp= H_BLANKING[7:0] |
| | Front Porch | Thfp | 2 | 8 | 75 | DCLK | |
| | Pulse Width | Thw | 2 | 4 | 43 | DCLK | |
| VSYNC | Period Time | Tv | 244 | 260 | 289 | HSYNC | |
| | Display Period | Tvdisp | | 240 | | HSYNC | |
| | Back Porch | Tvbp | 2 | 12 | 12 | HSYNC | SYNC mode back porch control by V_BLANKING[7:0] setting Tvbp= V_BLANKING[7:0] |
| | Front Porch | Tvfp | 2 | 8 | 37 | HSYNC | |
| | Pulse Width | Tvw | 2 | 4 | 12 | HSYNC | |

Note: It is necessary to keep Tvbp =12 and Thbp =43 in sync mode. DE mode is unnecessary to keep it.

6-8 Serial RGB Input Timing Table

Serial 8-bit RGB Input Timing (PVDD=VDD=VDDI= 3.3V, AGND= 0V, TA=25°C)

| Serial 8-bit RGB Input Timing Table | | | | | | | |
|-------------------------------------|----------------|--------|------|------|------|--------|----------------------------------------------------------------------------------|
| Item | Symbol | Min. | Typ. | Max. | Unit | Remark | |
| DCLK Frequency | Fclk | 15 | 18 | 21 | MHz | | |
| DCLK Period | Tclk | 47 | 55 | 66 | ns | | |
| HSYNC | Period Time | Th | 965 | 1011 | 1078 | DCLK | |
| | Display Period | Thdisp | | 960 | | DCLK | |
| | Back Porch | Thbp | 3 | 43 | 43 | DCLK | SYNC mode back porch control by H_BLANKING[7:0] setting Thbp= H_BLANKING[7:0] |
| | Front Porch | Thfp | 2 | 8 | 75 | DCLK | |
| | Pulse Width | Thw | 2 | 4 | 43 | DCLK | |
| VSYNC | Period Time | Tv | 244 | 260 | 289 | HSYNC | |
| | Display Period | Tvdisp | | 240 | | HSYNC | |
| | Back Porch | Tvbp | 2 | 12 | 12 | HSYNC | SYNC mode back porch control by V_BLANKING[7:0] setting Tvbp= V_BLANKING[7:0] |
| | Front Porch | Tvfp | 2 | 8 | 37 | HSYNC | |
| | Pulse Width | Tvw | 2 | 4 | 12 | HSYNC | |

Note: It is necessary to keep Tvbp =12 and Thbp =43 in sync mode. DE mode is unnecessary to keep it.

6-9 3-wire Serial Interface

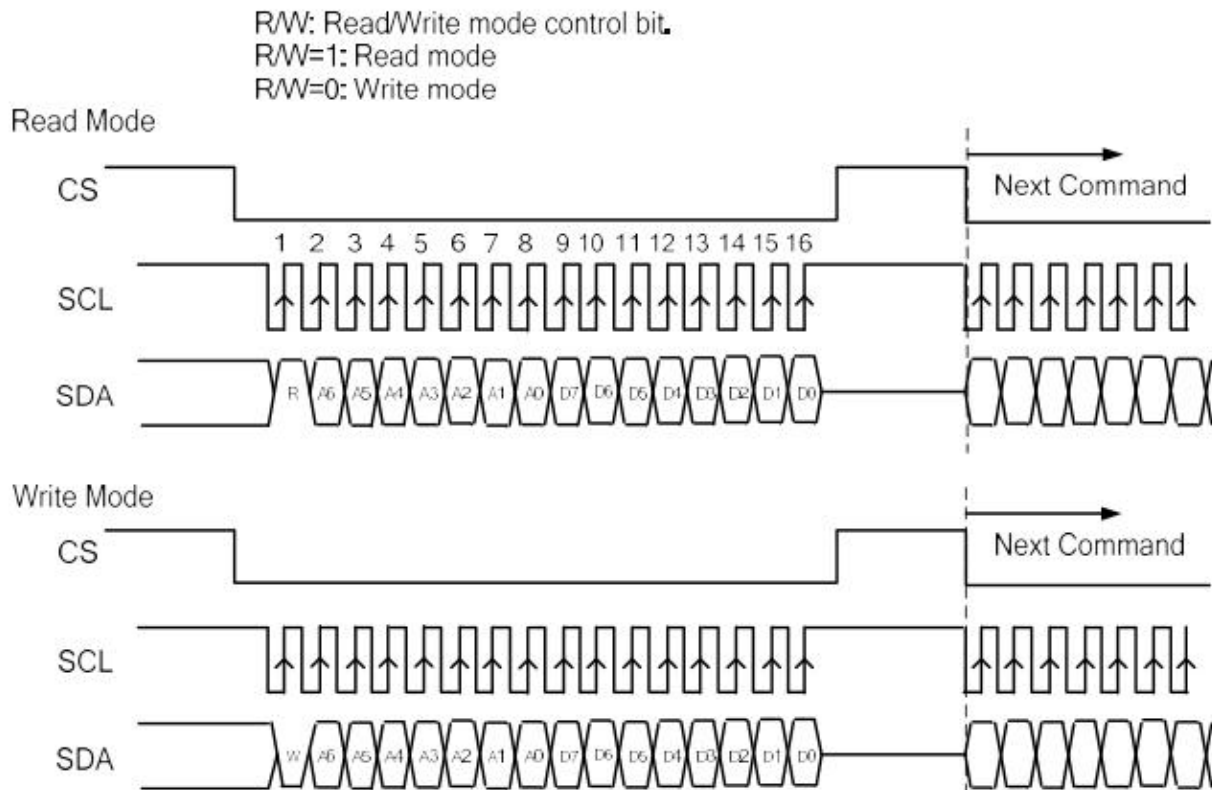

- a. Each serial command consists of 16 bits of data which is loaded one bit a time at the rising edge of serial clock SCL.
- b. Command loading operation starts from the falling edge of CS and is completed at the next rising edge of CS.
- c. The serial control block is operational after power on reset, but commands are established by the VSYNC signal. If command is transferred multiple times for the same register, the last command before the VSYNC signal is valid.
- d. If less than 16 bits of SCL are input while CS is low, the transferred data is ignored.
- e. If 16 bits or more of SCL are input while CS is low, the previous 16 bits of transferred data before then rising edge of CS pulse are valid data.
- f. Serial block operates with the SCL clock
- g. Serial data can be accepted in the power save mode.
- h. After power on reset or GRB reset, it is required 100ms delay to begin SPI communication.

6-10 System Bus Timing for 3-Wire SPI Interface

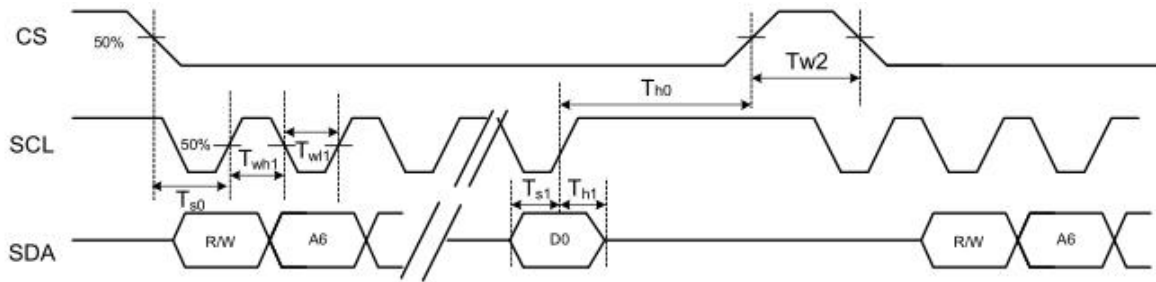

| Item | Symbol | Min. | Typ. | Max. | Unit | Conditions |
|------------------------------|--------|------|------|------|------|------------|
| CS Input Setup Time | Ts0 | 50 | - | - | ns | |
| Serial Data Input Setup Time | Ts1 | 50 | - | - | ns | |
| CS Input Hold Time | Th0 | 50 | - | - | ns | |
| Serial Data Input Hold Time | Th1 | 50 | - | - | ns | |
| SCL Write Pulse High Width | Twh1 | 50 | - | - | ns | |
| SCL Write Pulse Low Width | Twl1 | 50 | - | - | ns | |
| SCL Read Pulse High Width | Trh1 | 300 | | | ns | |
| SCL Read Pulse Low Width | Trl1 | 300 | | | ns | |
| CS Pulse High Width | Tw2 | 400 | - | - | ns | |

6-11 CTP Host Interface Diagram

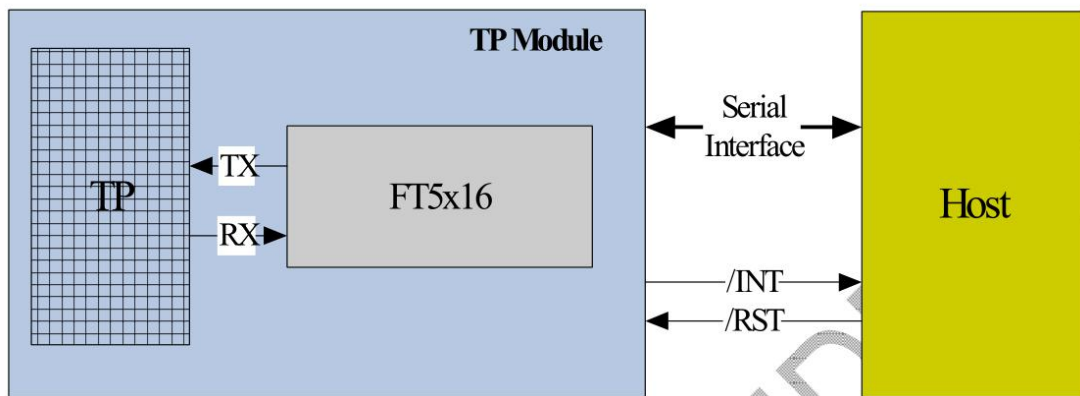

6-12 CTP I2C serial data transfer format

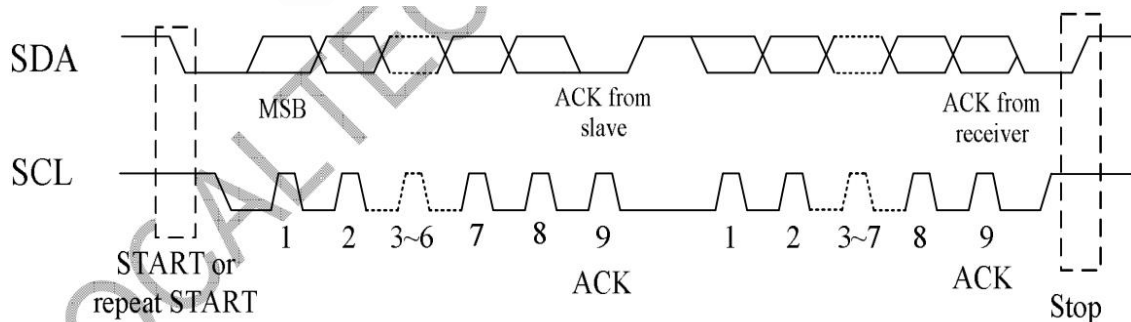

7. RELIABILITY TEST

7-1 Temperature and Humidity

| Test Item | Test Condition | Check Time |
|-------------------------------------|-----------------|------------|
| High Temp Storage | Ta= 85°C | 240 hrs |
| Low Temp Storage | Ta= -40°C | 240 hrs |
| High Temp Operation | Ta= 85°C | 240 hrs |
| Low Temp Operation | Ta= -30°C | 240 hrs |
| High Temp & High Humidity Operation | Ta=60°C H=90%RH | 240 hrs |

Note: (1) Ta : Ambient temperature

(2) All judgments of display are performed after temp of panel returns to room temperature

(3) Display function should be no change under normal operating condition.

(4) Under no condensation of dew

(5)*INX only guarantee the above 5 test items. INX wouldn't guarantee the others not shown as the above ones..

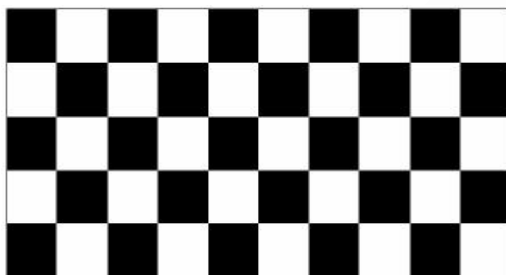

(a) Test Pattern (chess board Pattern)



(b) Gray Pattern

7-2 Shock and Vibration

| ITEMS | CONDITIONS |
|--------------------------------------|-----------------------------------------------------------------------------------------------------------------------------------------------------------------------------|
| Packing Shock (Non-Operation) | <ul style="list-style-type: none"> ● Shock level:980m/s² ● Waveform:1/2 Sine wave,6msec ● ±X, ±Y ±Z,each axis 1 times |
| Packing Vibration (Non-Operation) | <ul style="list-style-type: none"> ● Frequency range:8-33.3HZ ● Stoke:1.0mm ● Sweep: 10Hz-50Hz ● x,y,z 2 hours for each direction |

7-3 Electrostatic Discharge

| TEST ITEM | CONDITIONS |
|------------------------|-------------------------------------------|
| ESD (Non-operation) | 150pF,330Ω , Contact±4KV,Air :±8KV.Note 1 |
| | 200pF,0Ω , ±200V Contact test.Note 2 |

Note:Measure Point:

1.LCD glass and metal bezel

2.IF connector pins

8.HANDDLING & CAUTIONS

8-1 Caution For Operation

◆Since the LCM is made of glass, do not apply strong mechanical impact or static load onto it. Handling with care since shock, vibration, and careless handling may seriously affect the product. If it falls from a high place or receives a strong shock, the glass maybe broken.

◆It is indispensable to drive the LCM within the specified voltage limit since the higher voltage than the limit causes LCM's life shorter. An electro-chemical reaction due to DC causes undesirable deterioration of the LCM so that the use of DC drive should avoid.

◆Do not connect or disconnect the LCM to or from the system when power is on.

◆Never use the LCM under abnormal conditions of high temperature and high humidity.

◆When expose to drastic fluctuation of temperature(hot to cold or cold to hot), the LCM may be affected; specifically, drastic temperature fluctuation from cold to hot, produces dew on the LCM's surface which may affect the operation of the polarizer on the LCM.

◆Response time will be extremely delay at lower temperature than the operating temperature range and on the other hand LCM may turn black at temperature above its operational range. However those phenomenon do not mean malfunction or out of order with the LCM. The LCM will revert to normal operation once the temperature returns to the recommended temperature range for normal operation.

◆Do not display the fixed pattern for a long time because it may develop image sticking due to the LCM structure. If the screen is displayed with fixed pattern, use a screen saver. It is recommended to display the fixed mode for no more than 2 minutes or less.

◆Do not disassemble and/or re-assemble LCM module

7-2 Caution Against Static Charge

◆The LCM use C-MOS LSI drivers, so customers are recommended that any unused input terminal would be connected to Vdd or Vss, do not input any signals before power is turn on, and ground you body, work/assembly area, assembly equipments to protect against static electricity.

◆Remove the protective film slowly, keeping the removing direction approximate 30-degree not vertical from panel surface, if possible, under ESD control device like ion blower, and the humidity of working room should be kept over 50%RH to reduce the risk of static charge.

◆Avoid the use work clothing made of synthetic fibers. We recommend cotton clothing or other conductivity-treated fibers.

◆In handling the LCM, wear non-charged material gloves. And the conducting wrist to the earth and the conducting shoes to the earth are necessary

- - - END - - -